

DIN 69880 AXIAL STATIC HOLDERS

TYPE

C3 C4

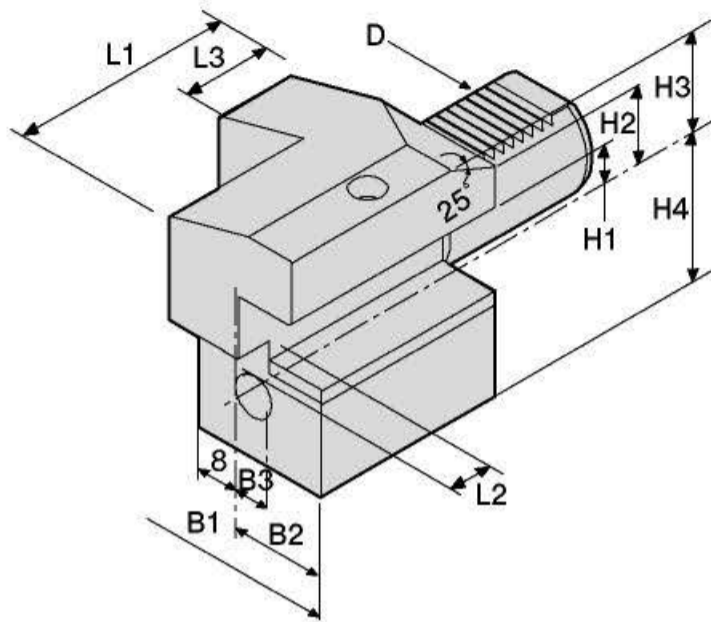

C3

- Right-hand
- External Coolant Supply

DIMENSIONS

D	B1	B2	B3	H1	H2	H3	H4	L1	L2	L3	Order No.
20	65	40	26	16(5/8")	23	30	25	50	7	30	C3-20x16(5/8")
30	70	35	17	20(3/4")	28	38	35	70	10	30	C3-30x20(3/4")
40	85	42.5	21	25(1")	-	48	42.5	85	12.5	30	C3-40x25(1")
50	100	50	26	32(1-1/4")	-	60	50	100	16	40	C3-50x32(1-1/4")
60	125	62.5	33	32(1-1/4")	-	62.5	62.5	125	16	40	C3-60x32(1-1/4")

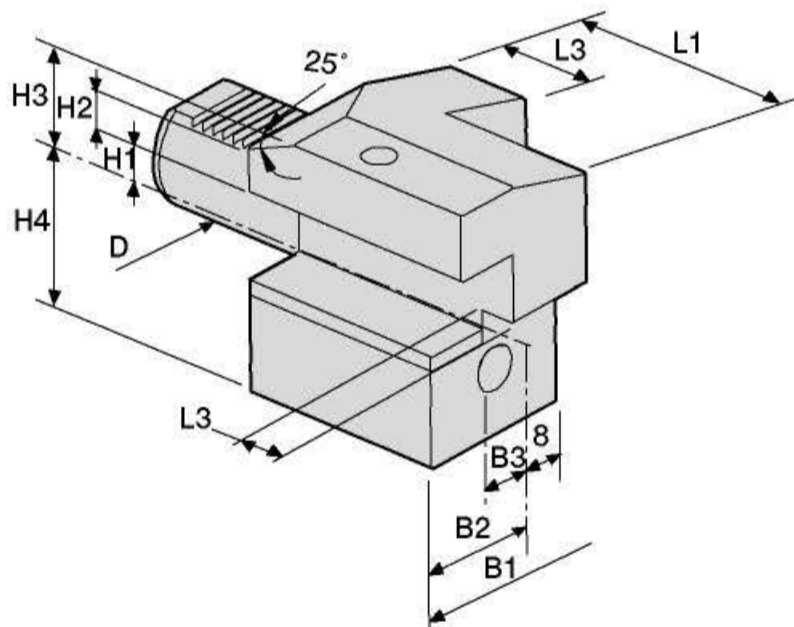

C4

- Left-hand
- External Coolant Supply

DIMENSIONS

D	B1	B2	B3	H1	H2	H3	H4	L1	L2	L3	Order No.
20	65	40	26	16(5/8")	23	30	25	50	7	30	C4-20x16(5/8")
30	76	41	23	20(3/4")	28	38	35	70	10	30	C4-30x20(3/4")
40	90	47.5	25.5	25(1")	-	48	42.5	85	12.5	30	C4-40x25(1")
50	105	55	30.5	32(1-1/4")	-	60	50	100	16	40	C4-50x32(1-1/4")
60	125	62.5	33	32(1-1/4")	-	62.5	62.5	125	16	40	C4-60x32(1-1/4")